



 Bluetooth® 5.2

PACKTALK NEO

.....
MANUAL



SOUND BY



DYNAMIC
MESH
COMMUNICATION



OPERATED BY
NATURAL VOICE



CONTENTS

1. Introduction	3
2. Getting Started	4
2.1 Getting to Know Your PACKTALK NEO	4
2.2 Charging Your PACKTALK NEO	4
2.3 Switching Your Unit On/Off	5
2.4 Using Your PACKTALK NEO	5
2.5 Pairing Your Unit to Bluetooth Devices	5
3. Cardo Connect App	8
3.1 Registering Your unit	8
3.2 Updating Your Unit	9
4. On the Road	10
4.1 Basic Audio Functions	10
4.2 Making and Receiving Phone Calls	11
4.3 Streaming Music	12
4.4 Listening to FM Radio	14
4.5 Voice Commands	16
5. Riding with Others	18
5.1 DMC Intercom	18
5.1.1 Setting Up and Using DMC Intercom Groups	18
5.1.2 Using DMC Intercom	20
5.2 Bluetooth Intercom	22
5.2.1 Setting Up non-DMC Intercom	23
5.2.2 Using the Bluetooth intercom	24
5.3 Sharing Music	25
5.4 Switching between Intercom modes	26
6. Troubleshooting	27
6.1 Soft Reset	27
6.2 Reset to Factory Settings	27
6.3 FAQ	27
7. Personalizing Your Device	28
7.1 Using Parallel Audio Streaming	28
7.2 Audio Source Priorities	29
8. Support	30



1. INTRODUCTION

Thank you for choosing the Cardo PACKTALK NEO communication and entertainment system for motorcycle helmets.

We wish you a great PACKTALK NEO experience and encourage you to visit the [support page](#) regarding any questions, suggestions or comments you may have.

If you have not yet installed the PACKTALK NEO unit on your helmet, please install it as described in the Installation Guide provided in the package. You can also watch the installation video accessible on this [link](#).

For easy reference while on the road, download the Pocket Guide [here](#).

Before using your unit for the first time, download the Cardo Connect App and follow the on-screen instructions to update your PACKTALK NEO to the latest software.

This is version 1.0 of the PACKTALK NEO Manual. The latest version of the manuals in your preferred language and various tutorials can be found [here](#).

2. GETTING STARTED

2.1 GETTING TO KNOW YOUR PACKTALK NEO

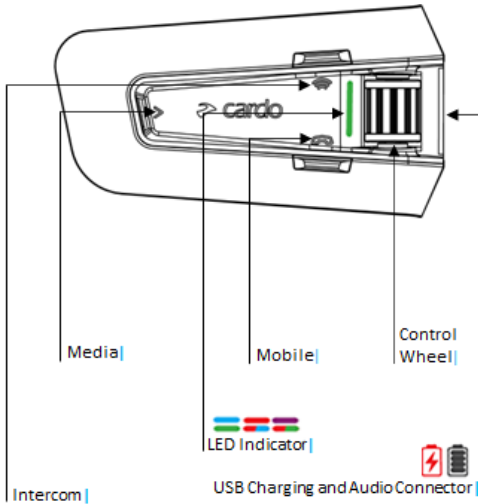

2.2 CHARGING YOUR PACKTALK NEO

Make sure that your PACKTALK NEO battery is charged for at least 4 hours before initial use.

To charge the unit:

1. Using the supplied USB cable, connect your computer or wall charger to the USB port on your PACKTALK NEO.

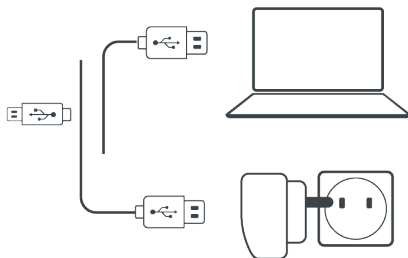

2. Fast charging:

- You will have 2 hours of talk time after 20 minutes of charging. (1.5 - 2 hours for full charge).

While charging, the LED indicates the charging status as follows:

- Red LED on – charging
- Red LED off – charging complete

TIP: You can check the battery charge at any time in the Cardo Connect App, or by saying "Hey Cardo, battery status".

2.3 SWITCHING YOUR UNIT ON/OFF

To switch your PACKTALK NEO on:

- Press both  and  for **2 seconds**.

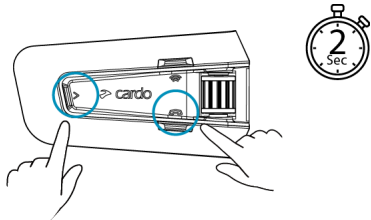

The speaker plays a startup sound.

The LED confirms your PACKTALK NEO is on:

- Normal battery – LED flashes blue once, then green
- Low battery – LED flashes blue three times, then green
- Charging – LED flashes red and green

To switch your PACKTALK NEO off:

- Press  and  for 2 seconds.

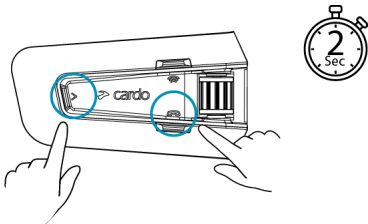

The LED flashes red three times, confirming that your unit is switching off. The speaker plays a sound and a voice message indicates the battery status, "Battery Status X%, ".

2.4 USING YOUR PACKTALK NEO

You can operate the various features of your PACKTALK NEO in the following ways:

- Press a button or a combination of buttons on the unit
- Use the Cardo Connect App on your mobile device (once it is paired with the unit)
- Use natural voice operation (by saying a command, for example **"Hey Cardo, Radio On"**)

2.5 PAIRING YOUR UNIT TO BLUETOOTH DEVICES

Your PACKTALK NEO has two Bluetooth channels for connection to Bluetooth devices such as mobile phones, GPS devices, and TFT Bike Infotainment.

To connect your unit to a Bluetooth device, you must first pair them. Once paired, they automatically recognize each other whenever they are within range.

- If you are pairing the unit to more than one mobile phone, the phone paired with channel 1 is the default phone for outgoing calls.

To pair to a mobile phone:

1. Enable Bluetooth on your mobile phone.
2. On the unit in standby mode, press  for **5 seconds**.

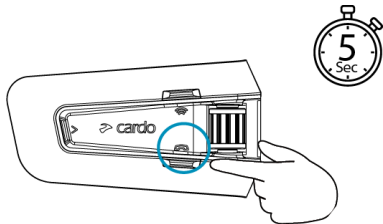

The LED flashes red and blue.

3. On your mobile phone, search for Bluetooth devices.
4. When your PACKTALK NEO appears in the list of available devices, select it.
If prompted for a PIN or Passkey, enter 0000 (four zeros). If prompted to allow pairing on your phone, allow it.

The phone confirms that pairing has succeeded and the LED flashes purple for 2 seconds. A voice message confirms "Phone connected".

To stop phone pairing:

To pair to another Bluetooth device:

1. Enable Bluetooth on the device (for example, your second mobile phone, GPS device., or TFT).
2. On the unit in standby mode press  for **5 seconds**.



The LED flashes red and blue rapidly.

3. Depending on the Bluetooth device:
 - a. For a GPS, tap  once.
 - b. For a TFT, roll the control wheel backward.
 - c. For a second phone, roll the wheel forward.
The led flashes red and green.
4. On the device you are pairing, search for Bluetooth devices.



5. When your PACKTALK NEO appears in the list of available devices, select it. If prompted for a PIN or Passkey, enter 0000 (four zeros). If prompted to allow pairing on your phone, allow it.

The device confirms that pairing has succeeded and the LED flashes purple for 2 seconds.

- If pairing is not completed within 2 minutes, the unit automatically returns to Standby.
- Not all Bluetooth GPS devices allow connection to Bluetooth audio devices. Consult your GPS User Manual for more information.

3. CARDO CONNECT APP

The Cardo Connect App enables you to configure the settings of your PACKTALK NEO. In addition, the App offers you remote controlled operation from the screen of your smartphone.

3.1 REGISTERING YOUR UNIT

1. Download the Cardo Connect App.



2. Register your PACKTALK NEO.



3. Select your language.



3.2 UPDATING YOUR UNIT

Before using your unit for the first time, and whenever a new software update is available, make sure to have the latest software update. Updating with the latest software keeps your unit free of bugs and provides you with additional new functionalities.

Your PACKTALK NEO can be updated Over the Air, via Cardo Connect app.

To update your PACKTALK NEO unit with the Cardo Connect App:

Whenever a new software update is available, a pop-up will open on your App screen. Press Install and follow the on-screen instructions.

If you press Remind me later, the pop-up will re-open the next day.



To update your PACKTALK NEO:

1. Open Cardo Connect app.
2. Press **Settings**.
3. Select your unit.
4. Select the software version.
5. Press **Update Now**.

When the update is finished, press **Finish** to go back to the main screen.

To update your PACKTALK NEO unit with your computer:

1. Download and install the Cardo Update tool <https://www.cardosystems.com/update>.
2. Open Cardo Update.
3. Register (first time only).
4. Connect the unit to the computer using an USB cable and update the firmware.

Cardo Update on Windows/Mac - minimum requirements - Windows® 7/macOS x10.8.

4. ON THE ROAD

PACKTALK NEO makes it easy for you to receive phone calls and listen to music in a convenient and safe manner.

4.1 BASIC AUDIO FUNCTIONS

The basic audio functions are the same whether you are listening to music, speaking on the intercom, or having a phone conversation.

To turn the volume up:

- Roll the Control Wheel forwards.

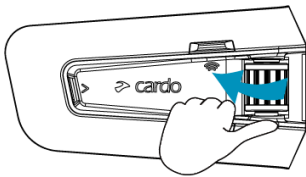

An increasingly louder tone is played on the speaker until you reach the maximum volume, as indicated by the maximum volume tone.

To turn the volume down:

- Roll the Control Wheel backwards.

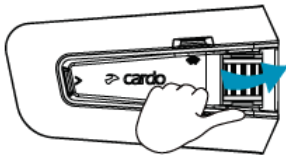

An increasingly quieter tone is played on the speaker until you reach the minimum volume, as indicated by the minimum volume tone.

To mute the microphone completely:

- Tap simultaneously on  and the intercom button .

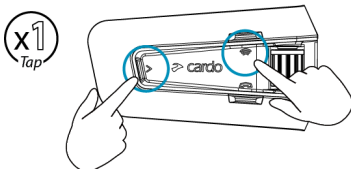

To unmute the microphone:

- Tap simultaneously on  and the intercom button .

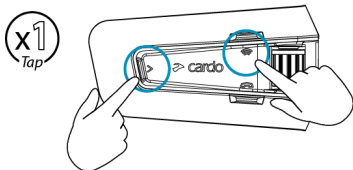

4.2 MAKING AND RECEIVING PHONE CALLS

You can use your mobile phone to make and receive phone calls while paired to your PACKTALK NEO.

You can make a hands-free call using your mobile phone's voice dial option or using the Cardo speed dial or redial last call options.

To make a phone call:

- To dial using your mobile phone's voice dial option, tap  or say **"Hey Siri"** (if you are using an iOS device) or **"OK Google"** (if you are using an Android device), then make your call as per the instructions for your mobile device.

To redial a phone number:

- To redial the last number called on your mobile device. Press the mobile button  for 2 seconds or say **"Hey Cardo, redial number"**.

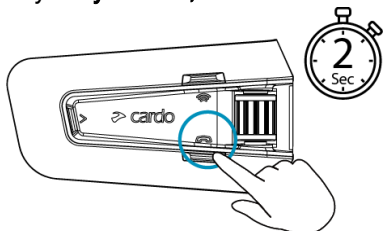

To set a speed dial number:

- On the Cardo Connect App, select "Phone". tap SET+ then select a contact.

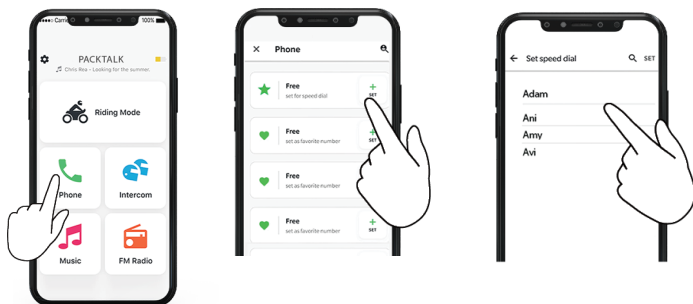

To call a preset speed dial number:

- Tap twice on the mobile button .

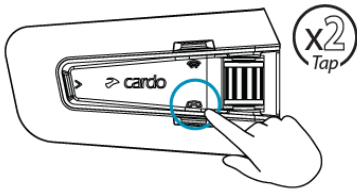

- If you connected two mobile phones to your unit, you cannot make an additional phone call from the other phone while a phone call is already active.
- During Bluetooth intercom 3 or 4-way calls, riders that are connected on both channels A and B cannot receive phone calls.

To answer a call:

- Tap the mobile button  or any other button, or tap the Control Wheel, or say "Answer".

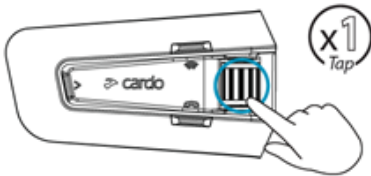

or

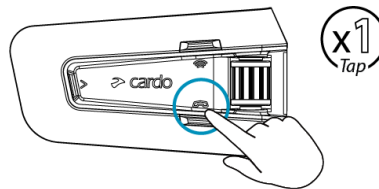

To ignore a call:

- Roll the Control Wheel backward or say "Ignore".

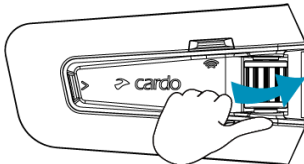

To end a call:

- Tap the mobile button or tap the Control wheel, or say "Hey Cardo, End Call".

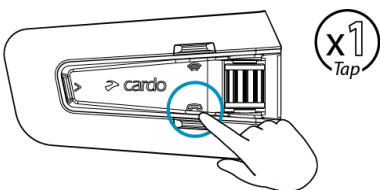

or

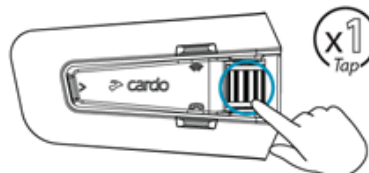

4.3 STREAMING MUSIC

You can stream music from your paired device to your PACKTALK NEO.

To start music streaming from your paired device:

- Tap  or say "Hey Cardo, music on".

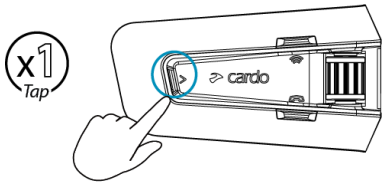

To stop music streaming:

- Tap the Control Wheel or say "Hey Cardo, music off".

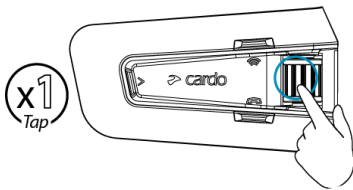

To skip to the next track (while streaming):

- Tap  or say "Hey Cardo, next track".

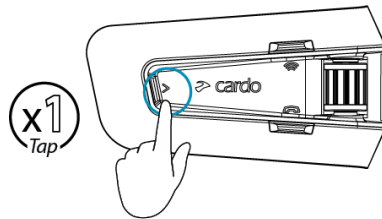

To skip back to the previous track (while streaming):

- Tap the Media button  twice or say "Hey Cardo, previous track".

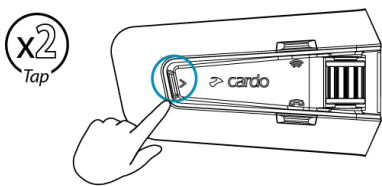

To share music with another rider:

- Press the Intercom  button for 2 seconds or say "Hey Cardo, share music".

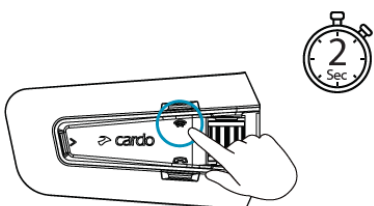

To toggle between FM and ATDP music:

- Press  for 2 seconds.

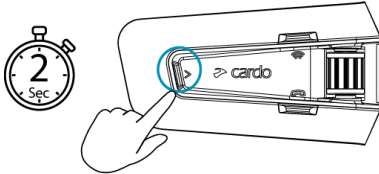

4.4 LISTENING TO FM RADIO

The PACKTALK NEO is equipped with a built-in FM radio.

To turn on the FM radio:

- Tap  twice or say "Hey Cardo, radio on".

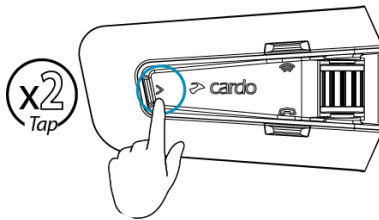

When you switch on your FM radio, the station that was playing when you last switched off resumes playing.

To turn the FM radio off:

- Tap the Control Wheel or say "Hey Cardo, radio off".

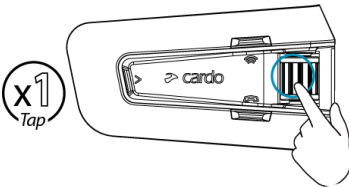

To skip to the next station:

- Tap  once or say "Hey Cardo, next station".

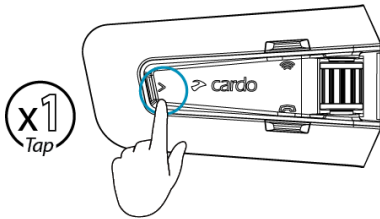

To skip back to the previous station:

- Tap  twice or say "Hey Cardo, previous station".

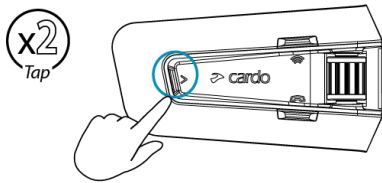

To scan for and select a station:

1. Tap  3 times.
The FM radio plays each station that it finds for several seconds.

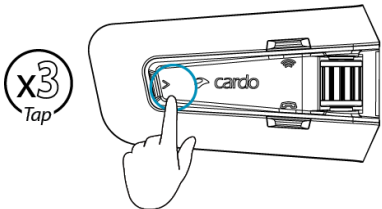

2. When you hear a station you want to select, tap .

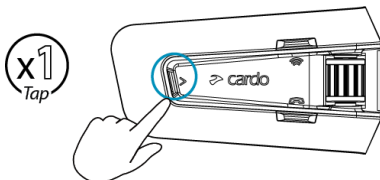

To store a scanned station in the active preset:

- Use the Cardo Connect App on your mobile device.

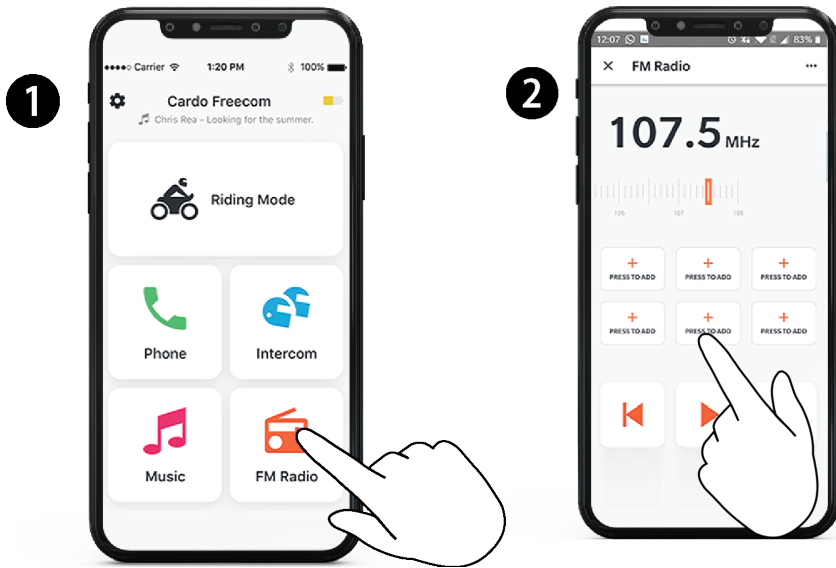

To toggle between FM and ATDP music:

- Press  for 2 seconds.

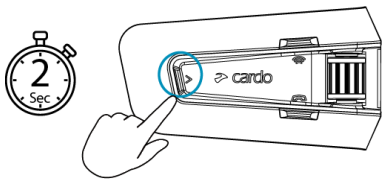

4.5 VOICE COMMANDS

You can use voice commands for hands-free operation of certain PACKTALK NEO features. Voice commands use natural voice operation. You say a command and PACKTALK NEO performs the action. Voice commands are available in various languages. English is the default language. You can change the language to another available language in the Cardo Connect App settings.

PACKTALK NEO uses the following predefined voice commands.

To ...	Say ...
Answer an incoming call	"Answer"
Ignore an incoming call	"Ignore"
End a call	"Hey Cardo, end call"
Call the default number (configurable)	"Hey Cardo, speed dial"
Redial the last number	"Hey Cardo, redial number"
Turn on music	"Hey Cardo, music on"
Turn off music	"Hey Cardo, music off"
Play the next music track	"Hey Cardo, next track"
Play the previous music track	"Hey Cardo, previous track"



To ...	Say ...
To share music`	"Hey Cardo, share music"
Turn on the radio	"Hey Cardo, radio on"
Turn off the radio	"Hey Cardo, radio off"
Skip to the next preset radio station	"Hey Cardo, next station"
Skip to the previous preset radio station	"Hey Cardo, previous station"
Open the call intercom (for Bluetooth Intercom)	"Hey Cardo, call intercom"
To close intercom call (for Bluetooth Intercom)	"Hey Cardo, end intercom"
Access Siri (when connected to an iOS device)	"Hey Siri"
Access Google (when connected to an Android device)	"OK Google" "Hey Google"
Raise volume	"Hey Cardo, volume up"
Lower volume	"Hey Cardo, volume down"
Mute audio	"Hey Cardo, mute audio"
Unmute audio	"Hey Cardo, unmute audio"
Mute microphone	"Hey Cardo, mute microphone"
Unmute microphone	"Hey Cardo, unmute microphone"
Check the battery status	"Hey Cardo, battery status"



5. RIDING WITH OTHERS

Your PACKTALK NEO features three distinct intercom communication modes: the traditional Bluetooth protocol, Live Intercom, and the Cardo's Dynamic Mesh Communications (DMC) technology.

DMC is the best way to communicate in a group. In DMC mode, you can instantly create or join a dynamically-fluid network of up to 15 riders to communicate in full conference mode. Unlike Bluetooth, DMC allows anyone in the group to roam freely, overtake each other or even leave the group altogether, without affecting the ongoing conversations of the remaining fellow riders. You can also use the DMC intercom to communicate privately with another rider.

Of course, you can still use Bluetooth to connect to devices, such as your smartphone or GPS, or to communicate with riders with headsets that don't include DMC technology. For details, see [Bluetooth Intercom](#) on page 22.

How Does DMC Work?

Anyone can start a new DMC group.

In DMC intercom mode, riders can join, leave, and rejoin existing DMC groups without affecting the ongoing conversation among the other group members. If a group member goes out of range, the remaining riders are automatically re-connected within split seconds to a closer group member, bypassing the absent or remote rider. This way, all active riders remain connected to each other.

5.1 DMC INTERCOM

You can use the DMC Intercom to speak with other riders in your DMC group. For more information on creating DMC Intercom groups, see [Creating DMC Intercom Groups](#) on page 19

Using the DMC Intercom, all riders in a group speak hands-free. A rider in a group performs no additional operation to speak to or hear other riders in the group.

Using the DMC intercom, you can also:

- Chat privately with another rider in your DMC group, see [Chatting Privately](#) on page 20.
- Bridge a non-DMC passenger or rider, see [Using DMC Intercom](#) on page 20.
- Mute/unmute DMC Intercom groups, see [Muting/Unmuting DMC Intercom Group](#) on page 21.
- Leaving DMC Intercom groups, see [leaving DMC Intercom Groups](#) on page 20.
- Listen to music while in DMC Intercom groups, see [Multiple audio sources and volume Management](#) on page 22.
- Switch between DMC Intercom and Bluetooth intercom, see [Switching between Intercom modes](#) on page 26.

5.1.1 SETTING UP AND USING DMC INTERCOM GROUPS

You can manage DMC Intercom groups to suit your riding requirements, this includes creating groups, joining groups, leaving and rejoining groups or changing your active group.

DMC Intercom groups are created by any PACKTALK NEO device. Each group can have up to 15 riders.

When creating a group, all members should be within 5 meters (16 feet).

When you are getting out of range from the group, a voice message announces that the group connection is lost, but your unit remains part of the group.

If your DMC group splits with some group members remaining in range of each other but not in range of all group members, you can continue speaking with the members still in range. Once in range of any other group member, you automatically reconnect.

If you join a new DMC group, you automatically leave your existing DMC group. You can go back to the group with Cardo Connect App.

- If you purchased the PACKTALK NEO DUO, the package contains two units belonging to the same DMC Intercom group. No group creation is required.

5.1.1.1 CREATING DMC INTERCOM GROUPS

When creating a DMC group, you must coordinate with the other riders who will be the group creator. When creating a group, all members should be within 5 meters (16 feet).

1. All the riders press  for 5 seconds. The LED flashes red and green quickly.

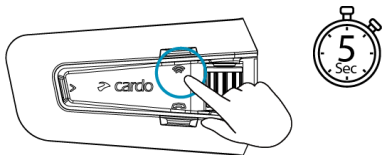

2. After each member joins successfully, the LEDs of the joined unit and the admin's unit announces how many riders are connected.

After grouping is completed, the DMC Intercom conference starts automatically.

When switching your unit ON, a voice message announces how many riders from your group are in the range.

To create a DMC group with a device from the previous generation of DMC, this device first initiates the group as Admin, and only after PACKTALK NEO devices can initiate grouping.

5.1.1.2 JOINING DMC INTERCOM GROUPS

You can join or rejoin a DMC Intercom group previously created.

To join an existing DMC group:

1. The group admin allows the additional rider by selecting "Add a rider" in the Cardo Connect App.
2. Press  for **5 seconds**. The LED flashes red and green quickly.

The color of the flashing LED indicates whether you have been added to the group:

- **Purple:** You have successfully joined the group.
- **Yellow:** You cannot join the group because it has already reached the maximum number of riders.
- **Red:** Failed to join.

5.1.1.3 LEAVING DMC INTERCOM GROUPS

You can leave a DMC group, by deleting the group from the Cardo Connect App or by doing a full factory reset.

If you leave a DMC intercom group, you must rejoin it if you want to connect to it again in the future.

5.1.2 USING DMC INTERCOM

5.1.2.1 ADDING A NON-DMC PASSENGER

You can use the DMC bridging feature to add a non-DMC passenger to the intercom group.

To bridge a non-DMC passenger:

To add a Bluetooth passenger, use the Cardo Connect App:

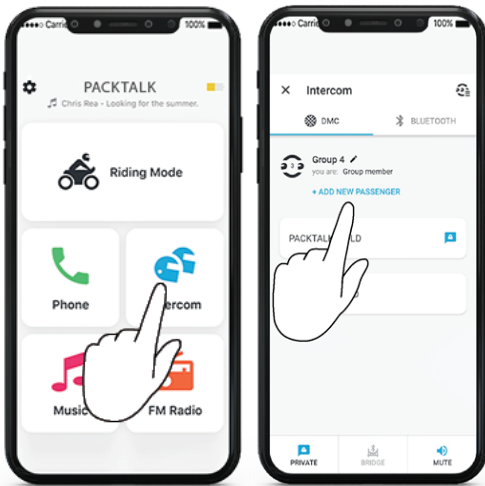

To start/stop a non-DMC passenger intercom:

- Tap  **3 times.**

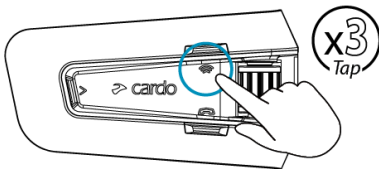

5.1.2.2 CHATTING PRIVATELY

You can chat privately with a specific member of your DMC group.

This option is also available using the Cardo mobile app.

To chat privately:

1. In the Mobile app, select the rider you want to speak to in private

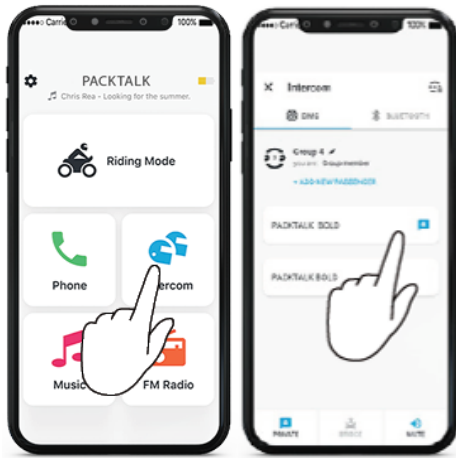

2. To start /stop a private chat, tap  twice.

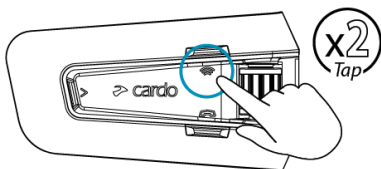

5.1.2.3 MUTING/UNMUTING DMC INTERCOM GROUP

Muting the DMC Intercom mutes your microphone and speaker for the intercom group communication. Your microphone and speakers are still active for phone calls and music. Unmuting brings you back to the group conversation.

To mute/unmute the DMC group:

- On your unit, press the control wheel for **2 seconds**.

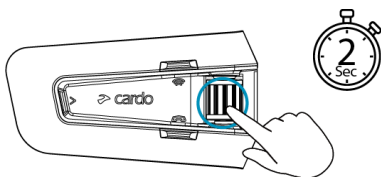

5.1.2.4 TO START/STOP SHARING A CALL:

To start/stop sharing a call:

To share a phone call with the riders in the DMC group press  for **2 seconds**.
All the riders can participate in the phone conversation.

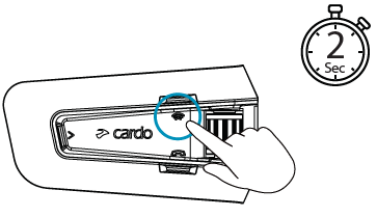

5.1.2.5 MULTIPLE AUDIO SOURCES AND VOLUME MANAGEMENT

DMC Intercom and FM Radio:

The PACKTALK NEO can use parallel audio streaming to stream audio from two connected sources simultaneously, so that you can listen to your music or the FM radio while holding a DMC Intercom conversation. PACKTALK NEO automatically manages your music and FM radio volume while using DMC Intercom. PACKTALK NEO also automatically manages DMC Intercom volume with mobile phone calls and GPS.

DMC Intercom and mobile phone calls:

You can receive a phone call during a DMC conversation. The phone will ring simultaneously with the DMC conversation, and you will be able to inform the group that you are going to answer a call.

PACKTALK NEO also automatically manages DMC Intercom volume with Mobile phone calls.

DMC Intercom and GPS:

PACKTALK NEO automatically manages DMC Intercom volume with GPS.

5.2 BLUETOOTH INTERCOM

To connect your unit to another unit with a Bluetooth intercom, such as a Cardo Bluetooth unit or other Bluetooth-enabled devices, you must first pair their channels. Once paired, the unit automatically recognizes the other one whenever they are in range. But they will not connect automatically. To start a Bluetooth intercom call, see [Starting/Ending Bluetooth Intercom Calls](#) on page 24

- Pairing a channel replaces any existing paired unit on that channel with the new unit.
- If you purchased the PACKTALK NEO DUO, the retail package contains two pre-paired units.
- The Intercom range with other models is limited to the distance of the unit with the shorter range.

Your PACKTALK NEO Supports Live Intercom technology for the connection to Cardo Bluetooth intercom riders. In case of disconnection, Live Intercom enables an automatic reconnection to the other riders when you get back to the range:

- Once the other rider is disconnected, an announcement “Reconnecting” will be heard. Your unit will “beep” every 20 seconds while trying to reconnect.
- It is possible to terminate the reconnection attempts manually by tapping the intercom button once.
- The sequence of reconnection attempts is limited to 5 minutes. The intercom will be disconnected after this period of time, and you will need to initiate it.
- When you are connected to a regular Bluetooth unit, the reconnection will be initiated only from your side. When you are connected to a Cardo unit supporting Live Intercom, the reconnection will be initiated from both sides, and will be faster.

5.2.1 SETTING UP NON-DMC INTERCOM

DMC is always the best way to connect a group of riders. If you happen to ride with a group of riders that do not have DMC devices (such as Bluetooth communicators by Cardo or by other brands), you can switch your unit to Bluetooth mode and create or join a non-DMC group. The participating riders are connected in a chain with a maximum total of four riders.

To set up a non-DMC intercom (Cardo or non Cardo) :

1. Confirm your Cardo unit is in Standby Bluetooth intercom mode (LED flashes blue slowly).

If your unit is not in Bluetooth intercom mode, use the Cardo Connect App. Select intercom, then Bluetooth Mode. For more information see, [Switching between Intercom modes](#) on page 26.

Universal Bluetooth Intercom for non-Cardo units: a non-Cardo unit should be on phone pairing mode.

2. To initiate 2-way pairing:

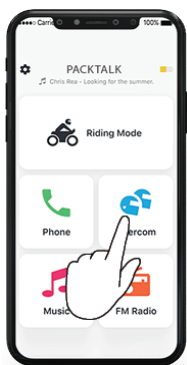
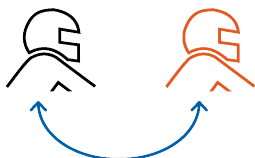

Select Intercom

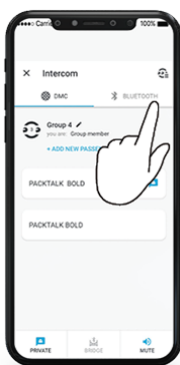

Switch to Bluetooth mode



Select the Bluetooth rider

Bluetooth intercom pairing needs to be initiated on the other device.

3. To add a 3rd rider:

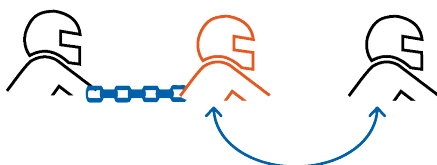

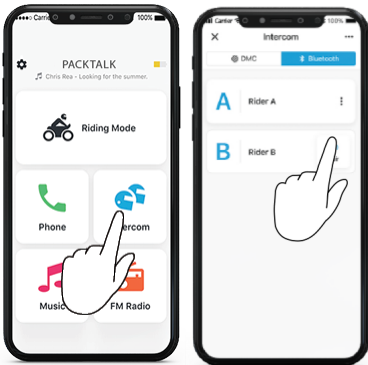

Bluetooth intercom pairing needs to be initiated on the other device.

- To add a 4th rider, Rider 1 or Rider 2 connects to the additional rider.

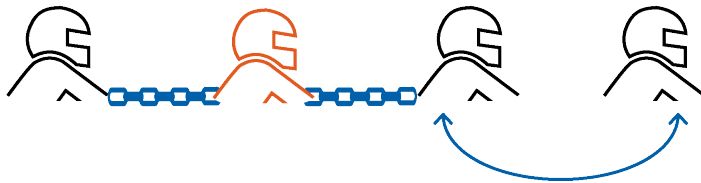

5.2.2 USING THE BLUETOOTH INTERCOM

5.2.2.1 STARTING/ENDING BLUETOOTH INTERCOM CALLS

To start or end communication with a rider:



- Tap  once

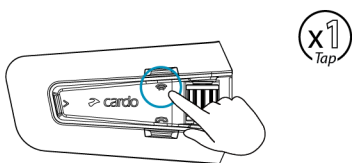

To start or end communication with Rider 2:

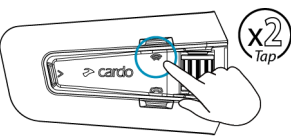
- Tap  twice 

To start or end a communication with Rider 1 and Rider 2 simultaneously, say "Hey Cardo, call intercom" or "Hey Cardo, end intercom".

5.2.2.2 RECEIVING BLUETOOTH INTERCOM CALLS

If another paired unit calls you via Bluetooth intercom, the call begins instantly.

5.3 SHARING MUSIC

You can share music with a passenger.

- Music can be shared with only one passenger.
- Bluetooth intercom calls are disabled when sharing music.
- If you paired your unit to two mobile phones, music will be shared from the mobile phone through which you last played music.
- When you stop sharing music, the music continues to play on your unit only.

To start sharing:

1. Set a sharing partner using the Cardo Connect App:

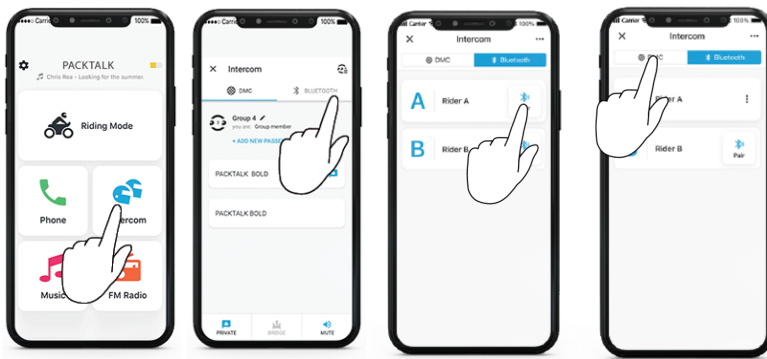

- If you have a Duo set you don't need to set up the sharing partner, it is pre-configured.

2. Start playing music.

3. Press  for 2 seconds to start sharing .

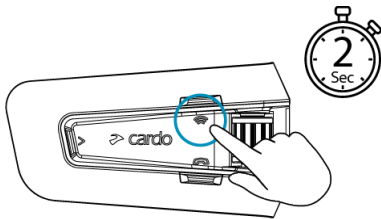

To stop sharing:

- Press  for 2 seconds.

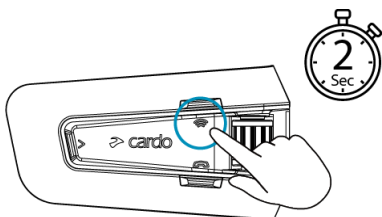

5.4 SWITCHING BETWEEN INTERCOM MODES

Your PACKTALK NEO unit can work in only one intercom mode at a time.

The current intercom mode is indicated by the color of the LED:

- When in DMC intercom mode, the LED flashes green at approximately 4-second intervals.
- When in Bluetooth intercom mode, the LED flashes blue at approximately 4-second intervals.

To switch between intercom modes:

- Use the Cardo Connect App.

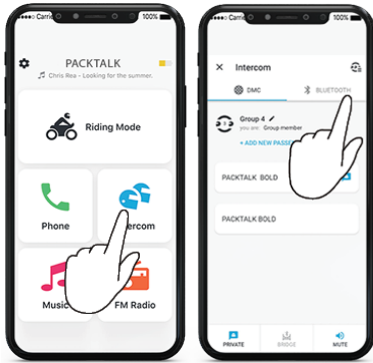

- Press  and  for 5 seconds

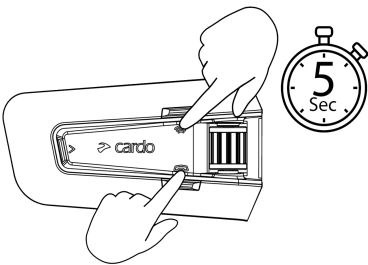



The color of the flashing LED changes and a voice message indicates the current intercom mode.

6. TROUBLESHOOTING

6.1 SOFT RESET

If your PACKTALK NEO stops responding, reset it in one of these ways:

- Turning it off and then on again (see Switching Your Unit On/Off).
- Rebooting the unit, by simultaneously pressing  +  for **10 seconds**.

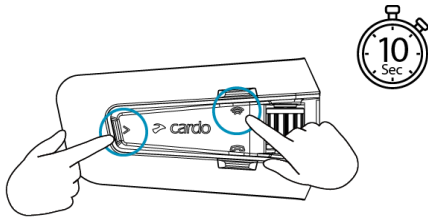

6.2 RESET TO FACTORY SETTINGS

This option deletes all paired units, devices and all configuration settings.

To perform a factory reset through the unit:

1. Check that your PACKTALK NEO is in Standby mode.
2. Simultaneously press  +  +  **10 seconds**.

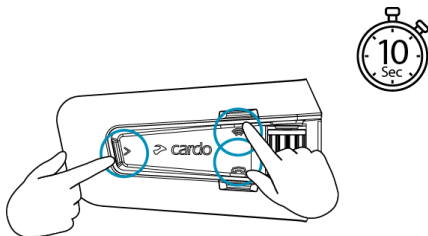

The LED flashes red **5 times**.

3. A factory reset can also be performed with the Cardo Connect App.

6.3 FAQ

Additional answers to common problems can be found at www.cardosystems.com/support/packtalk-neo/



7. PERSONALIZING YOUR DEVICE

Get the most out of your PACKTALK NEO by changing the settings and customizing your unit according to your own personal preferences, using the Cardo Connect App on iOS or Android devices.

Cardo recommends you customize your settings before going out. You can adjust any of these settings as required after experiencing them under dynamic conditions using the Cardo Connect App.

7.1 USING PARALLEL AUDIO STREAMING

With parallel audio streaming, you can hear GPS instructions during a mobile or Bluetooth intercom call, or while listening to other audio sources, such as music or FM radio.

- Parallel audio streaming may not work properly with some iOS devices (i.e., music player or GPS navigator) due to connected device limitations.

Your PACKTALK NEO sets the various audio sources to either foreground (volume remains the same) or background (volume reduced) as described in the following table:

Mobile Phone 1/2	GPS	Intercom 1	Intercom 2	Music	FM Radio
Foreground	Foreground				
Foreground¹		Foreground ¹			
	Foreground	Foreground			
	Foreground			Background	
	Foreground				Background
		Foreground		Background	
		Foreground			Background
		Foreground ^{2,3}	Foreground ^{2,3}		Background
					Foreground ⁵

¹If you add an intercom call to a mobile phone call creating a conference call, the volume for both audio sources is the same.

²If you make two intercom calls simultaneously creating an intercom conference call, the volume for both audio sources is the same.

³If you make two intercom calls simultaneously creating an intercom conference call, you cannot hear the mobile phone or GPS.

⁴If you play music only, the music volume is not reduced.

⁵If you play the FM radio only, the FM radio volume is not reduced.

- In some cases, parallel audio streaming may not work properly due to connected device limitations (music player or GPS navigator).

- Cardo recommends that during a 3-way or 4-way Bluetooth intercom conference call, the rider who is connected to only one intercom call listens for mobile phone and GPS announcements.

- You cannot use music sharing for voice audio with riders during parallel audio streaming.

- Music can be streamed in the background during an active DMC intercom call.



7.2 AUDIO SOURCE PRIORITIES

PACKTALK NEO manages the audio sources you hear through the speakers according to the following audio source priorities.

Priority	Audio Source
Higher Priority	GPS device instructions
↑	Phone calls
Lower Priority	Music or DMC Intercom

Phone calls temporarily mute DMC Intercom, but group members remain part of the DMC Intercom group.

Intercom modes all have the same priority. Ongoing intercom calls will not be interrupted by any other intercom call.



8. SUPPORT

For additional information:

www.cardosystems.com/support/packtalk-neo/

- To avoid potential problems and to receive our support and warranty coverage, we strongly recommend buying our products only from authorized Cardo dealers.
- Your favorite brick-and-mortar store is always your best bet. Unauthorized online resellers and online auction sites such as eBay are not among Cardo's authorized dealers, and purchasing our products from such sites will be at your own risk. Cardo strives to provide quality products and exceptional customer service. We select dealers who share that vision. Buying grey market items from unauthorized online dealers is counterproductive and also adversely affects unsuspecting online consumers who may be purchasing used, counterfeit or defective products or devices whose warranties are void. Protect your investment by purchasing genuine Cardo and scala rider® products only from authorized dealers.

© 2022 Cardo Systems

All rights reserved. Cardo, the Cardo logo and other Cardo marks are owned by Cardo and may be registered. All other trademarks are the property of their respective owners. Cardo Systems assumes no responsibility for any errors that may appear in this document. Information contained herein is subject to change without notice.